

MIXPRO 28 - 2,2 kW complete plaster continuous mixing machine - Chassis

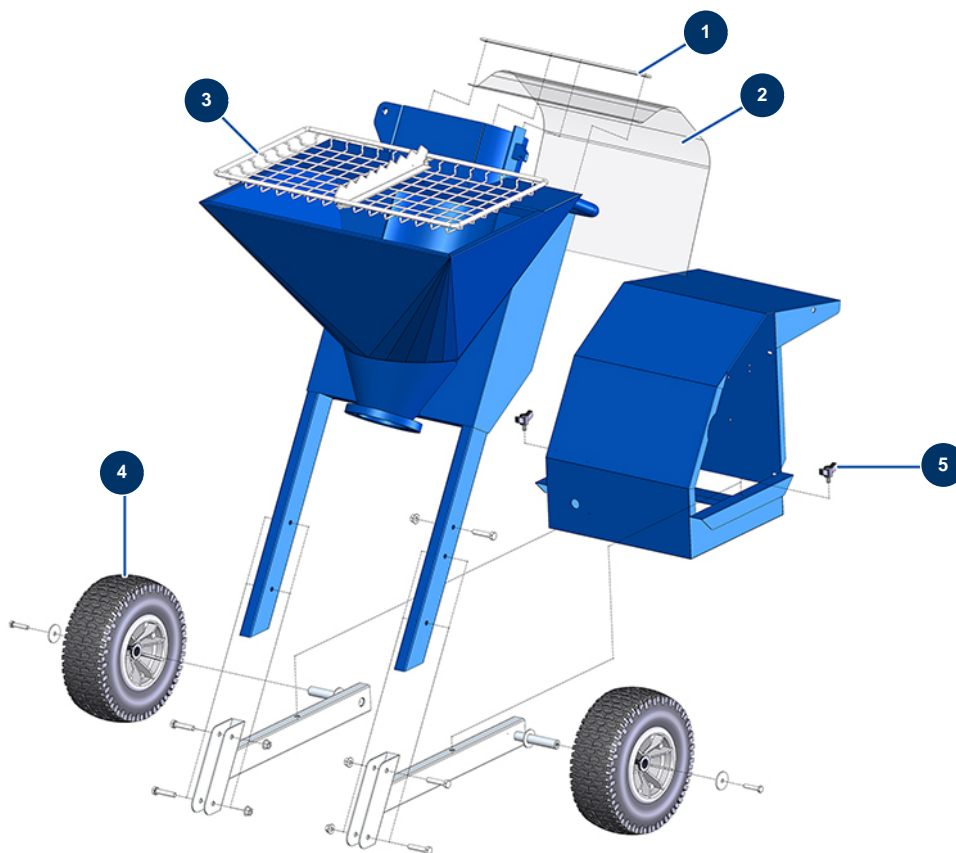

Détails des pièces

Pos.	Référence	Désignation
1	MI4023001800	MIXPRO 28 compressor protection fixing piece
2	MI4920001010	MIXPRO 28 compressor protection plastic
3	MI7017506100	MIXPRO 28, SPRINTER & MOSQUITO safety grid
4	12319	Complete wheel 320 with axle of 20
5	MI3T01505001	Mixer black Eye bolt diam 8

MIXPRO 28 - 2,2 kW complete plaster continuous mixing machine - Mixing group

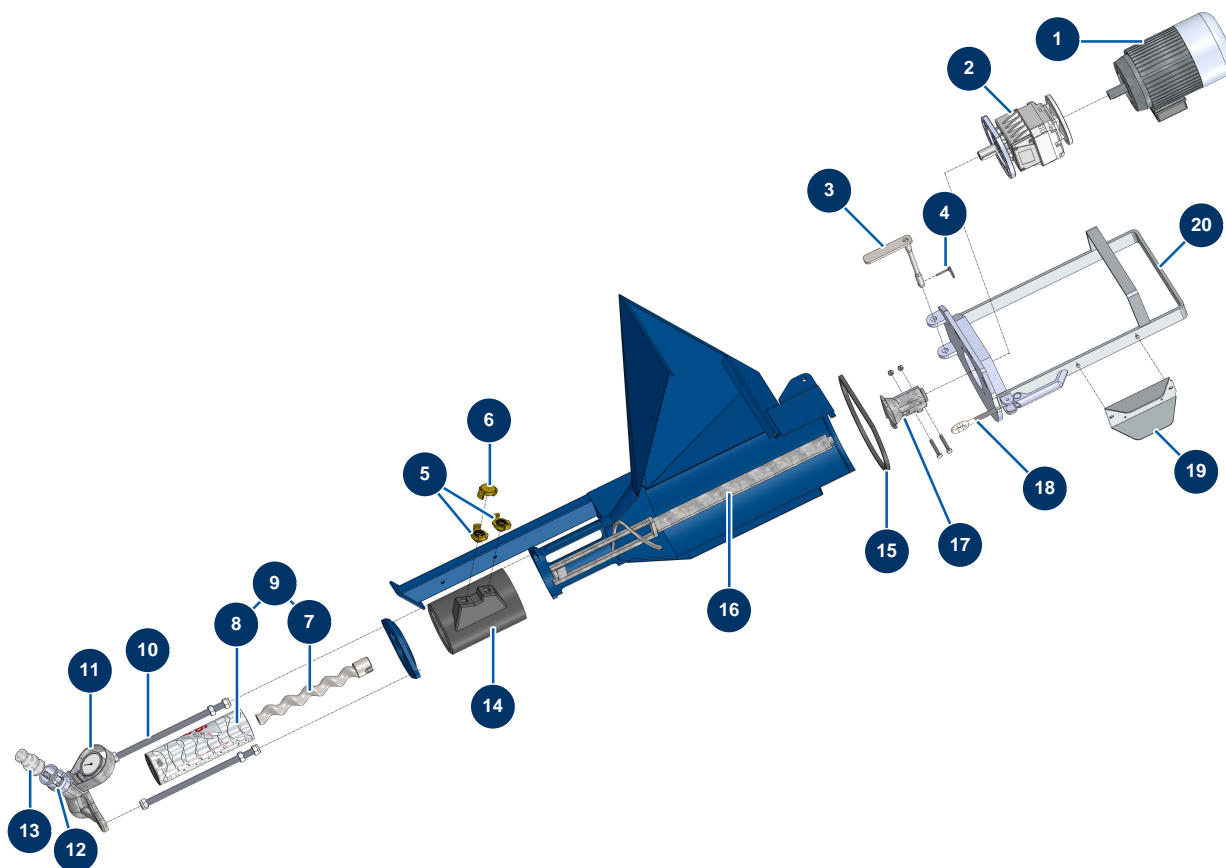

Détails des pièces

Pos.	Référence	Désignation
1	MI3D00200710	Electric motor 2,2 kW - T90 - B14 -2800 rpm - 400V
2	MI3D00310101	Coaxial speed reducer - T412A - R8,96 - B14/T90
3	C23358	
4	MI3T01200101	Clip pin
5	MI3A00100302	1/2" outer threaded Geka coupling
6	MI3A00100401	Geka coupling plug
7	MI7009012000	MIXER 26 D4-2 pump rotor with slit head
8	MI3F00501300	MIXER 26 D4-2 pump stator
9	30861	MIXER 26 pump rotor/stator kit - 16 L/min
10	MI8023003000	M16 tie rod L = 350 mm + screws
11	MI8012006000	LIGHT/MOSQUITO/SPRINTER/MIXPRO28 complete pump head
12	11951	1"1/4 camlock steel coupling, inner threaded 1"1/4

Pos.	Référence	Désignation
13	MI3A00300401	Double steel adapter ø 25 ø 35
14	MI7021004000	MIXPRO 28 mixing chamber
15	MI3G01000301	O-ring
16	MI7003020000	MIXPRO 28 & SPRINTER/MOSQUITO mixing shaft
17	MI700600650S	MOSQUITO/PLUS MONO/LIGHT/MIPRO28/MIXPRO30 motor coupling
18	MI3T01000400	Motor Closing Ring
19	MI4906511000	Mixpro 28 motor plug protection
20	C23037	

MIXPRO 28 - 2,2 kW complete plaster continuous mixing machine - Air group

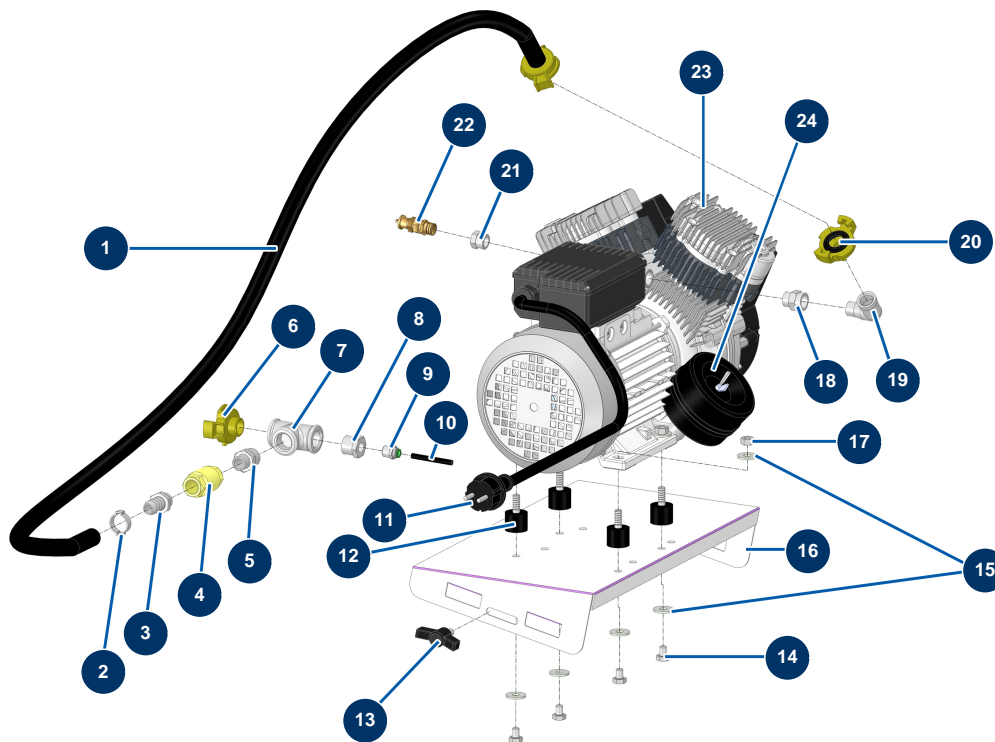

Détails des pièces

Pos.	Référence	Désignation
1	MI3F00700820	Air hose with 1 GEKA coupling MIXPRO 28
2	14578	2
3	MI3G50300202	Threaded connection 3/8" corrugated ø 14
4	MI3G01300401	3/8" non-return valve
5	80339	3/8" MaleC x 1/2" MaleC low-pressure nipple
6	MI3A00100302	1/2" outer threaded Geka coupling
7	MI3G00513002	Galvanised T F1/2" x F1/2" x F1/2"
8	30119	1/2" MaleC x 1/4" FemaleD low-pressure reduction
9	91039	Legris straight coupling M1/4 Ø 6
10	30403	Calibrated polyurethane tube ø 4 x 6 black by the metre
11	30023	2P male electric socket + foam rubber T
12	MI3T00200106	Silentbloc ø 25 x 20 M-F
13	MI3T01505001	Mixer black Eye bolt diam 8

Pos.	Référence	Désignation
14	30298	THEF 8 x 10 screw
15	30292	ø 8 inox large washer
16	C23348	16
17	90440	M 8 zinc plated nut
18	91053	3/8" MaleD x 3/8" FemaleD low-pressure nipple
19	MI3G50300503	19
20	MI3A00100201	3/8" inner threaded Geka coupling
21	MI3G50300110	3/8" MaleC x 1/4" FemaleC galvanised reduction
22	MI3G01300304	Safety Valve 1/4 3 bar
23	14421	Two-cylinder compression head Oilless - 230V/50Hz single-phase
24	MI3B02620000	

MIXPRO 28 - 2,2 kW complete plaster continuous mixing machine - Water group

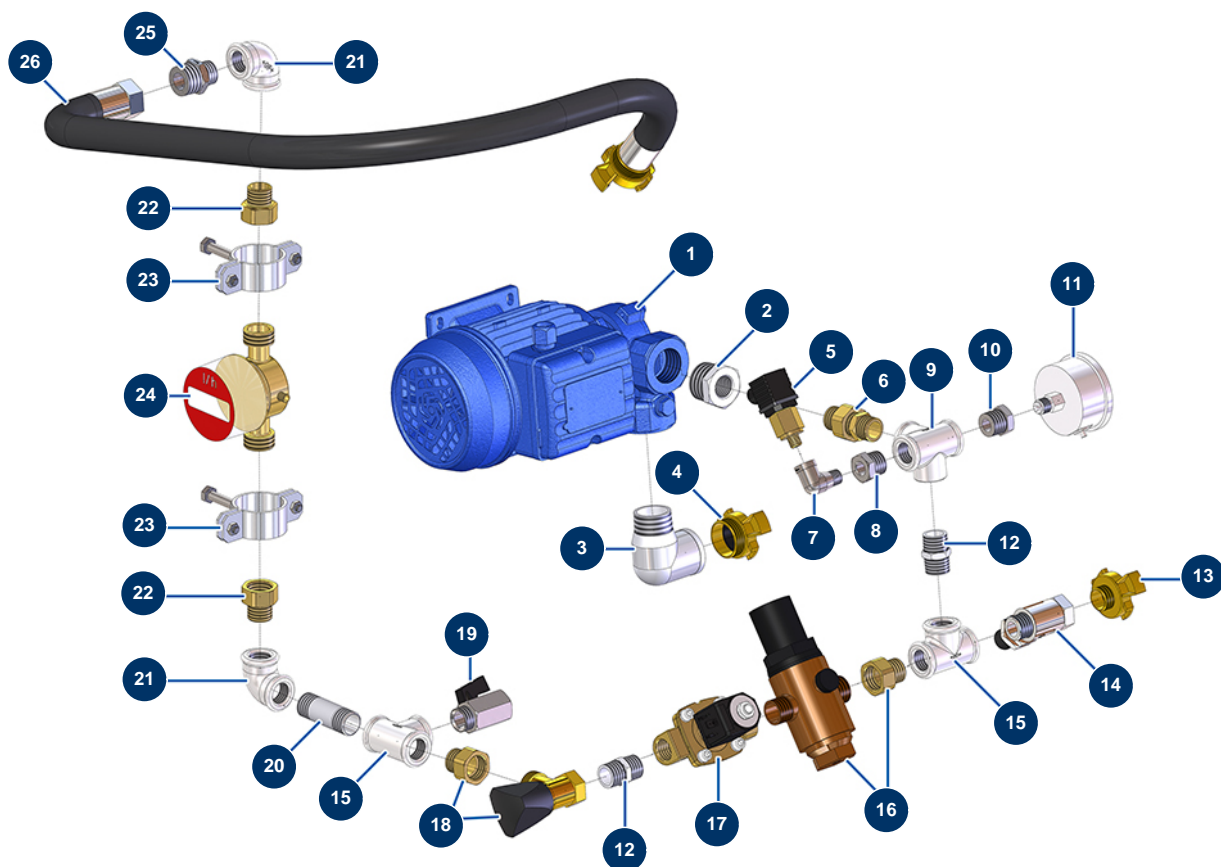

Détails des pièces

Pos.	Référence	Désignation
1	MI3D00703001	230V MONO electropump
2	MI3G00524105	1" MaleC x 1/2" FemaleC galvanised reduction
3	MI3G00509204	90° galvanised elbow 1" MaleC x 1" FemaleC
4	13574	1" GEKA outer threaded coupling
5	MI3G00402103	Water pressure switch
6	30132	Union coupling 1/2
7	30121	90° low-pressure elbow 1/4 MaleC x 1/4 FemaleD
8	MI3G50300100	1/2" MaleC x 1/4" FemaleC galvanised reduction
9	MI3G00522302	Galvanised X 4 x 1/2" Female
10	MI3G50300101	1/4" MaleC x 1/8" FemaleC galvanised reduction
11	MI3G00100141	0-10 bar manometer
12	MI3G00528002	Galvanised nipple 1/2" MaleC x 1/2" MaleC
13	13572	1/2" outer threaded Geka coupling"

Pos.	Référence	Désignation
14	90023	Red handle valve M1/2" x F1/2"
15	MI3G00513002	Galvanised T F1/2" x F1/2" x F1/2"
16	MI3G00904100	Water pressure regulator 0,5 to . bar
17	MI3G00301300	1/2 Parker solenoid valve
18	MI3G01300201	Water flow adjustment tap
19	30137	1/2" mini lux valve
20	MI3G00553006	Galvanised nipple 1/2" M-M length 60 mm
21	MI3G00509002	90° galvanised elbow 1/2" FemaleC x 1/2" FemaleC
22	MI3G01700300	3-piece union MF 1/2
23	MI3G01600101	Flowmeter fixing clamp
24	MI3G01100102	Digital flow meter
25	90868	3/4" MaleC x 1/2" MaleC high-pressure nipple
26	MI8002008004	Mixing chamber water supply hose ø 18 Lg. 700 mm

MIXPRO 28 - 2,2 kW complete plaster continuous mixing machine - Electrical box (since 09/2023)

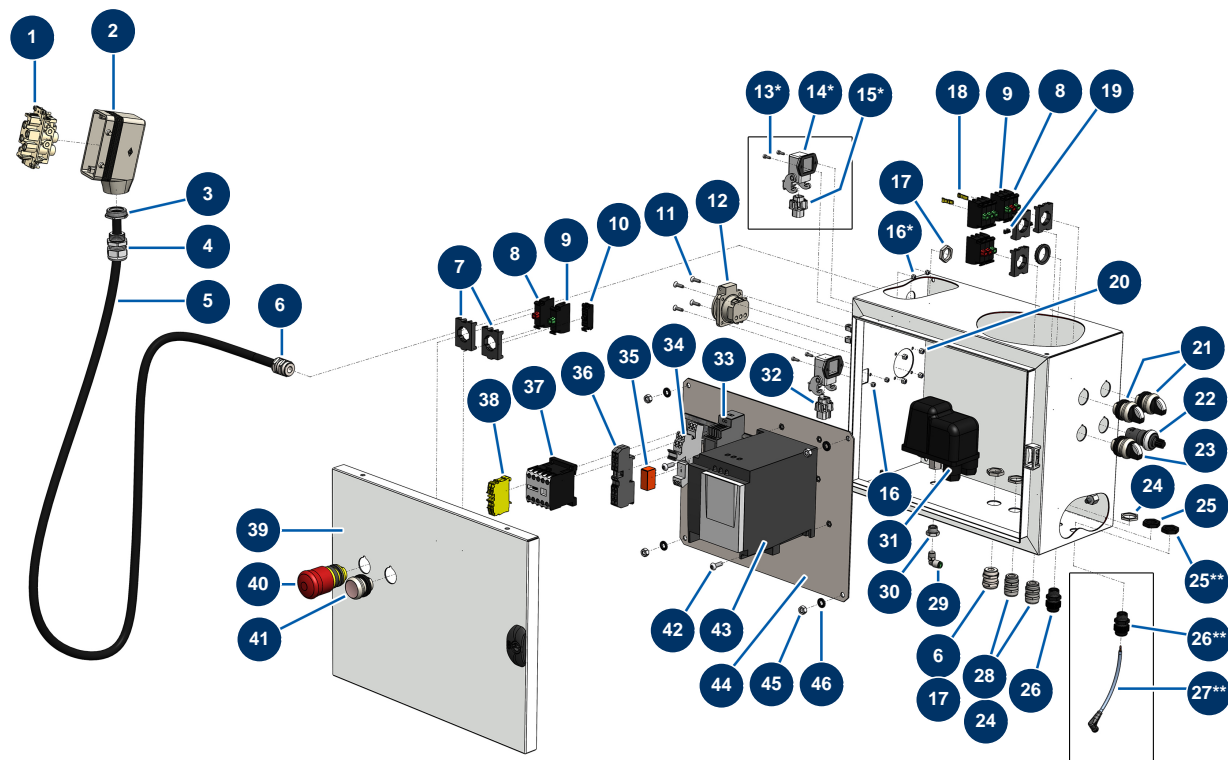

* Pièces pour option VIBRATEUR / Parts for VIBRATOR option
 ** Pièces pour option DÉBITMÈTRE NUMÉRIQUE / Parts for DIGITAL FLOWMETER option

Détails des pièces

Pos.	Référence	Désignation
1	MI3C02700600	Female motor safety socket
2	MI3C02800100	Mobile Base
3	90719	Cable gland reduction 21-16
4	MI3C04200200	PG16 cable gland
5	12131	OLFLEX CLASSIC 110 8G1.5 electrical cable by the metre
6	80448	M 20 waterproof cable gland
7	30036	3-contact U-bolt
8	30356	Red single open contact
9	30028	Green single closed contact
10	14665	Led Bulb 24 VDC multicoloured
11	13912	4 x 16 countersunk head screw
12	90489	2P recessed socket + t with grey valve

Pos.	Référence	Désignation
13*	310011	3 x 10 cylindrical head screw
14*	12543	Insulating bend socket base 3p + G - 1 lever
15*	11912	Blowing machine female insert 3 p + T
16	12737	M 3 nylstop nut
16*	12737	M 3 nylstop nut
17	11197	M 20 cable gland nut
18	80644	Coding part for MOELLER button
19	13518	
20	30266	M 4 nylstop nut
21	90731	3-position button
22	80645	Spraying machine complete potentiometer from MARCH 2003
23	30025	2-position button
24	30060	11mm cable gland nut
25	1002838	PG 9 cable gland nut
25**	1002838	PG 9 cable gland nut
26	1002837	PG 09 watertight cable gland
26**	1002837	PG 09 watertight cable gland
27**	MI3G01100103	Cable fordigital flow meter
28	30082	Nickel plated watertight cable gland of 11
29	30124	Corrugated Legris coupling M1/8" Ø 6
30	90240	1/4" MaleC x 1/8" FemaleD low-pressure reduction
31	MI3G00403106	Pressure switch PT/5 - 0.6-2 Bar
32	11914	Female insert 4p + G
33	12711	Supply 230V-24VDC-15W
34	13139	Miniature plug-in relay socket 24V VDC - 2RT
35	13140	Miniature plug-in relay 24V VDC - 2RT
36	80482	Grey conductor block 6 mm ²
37	30011	230 Volt coil switch for sprayer
38	30038	Yellow and green conductive block 6 mm ²
39	MI3C00107300	
40	90727	Hook emergency stop button - CP 60
41	30035	Impulse transparent indicator button
42	11735	Inox mushroom head screw M 5 x 16
43	80459	Inverter 230 V - 2.2 KW

Pos.	Référence	Désignation
44	C23463	44
45	10038	M 6 nut
46	80265	46

MIXPRO 28 - 2,2 kW complete plaster continuous mixing machine - Electrical box (from 01/2021 to 08/2023)

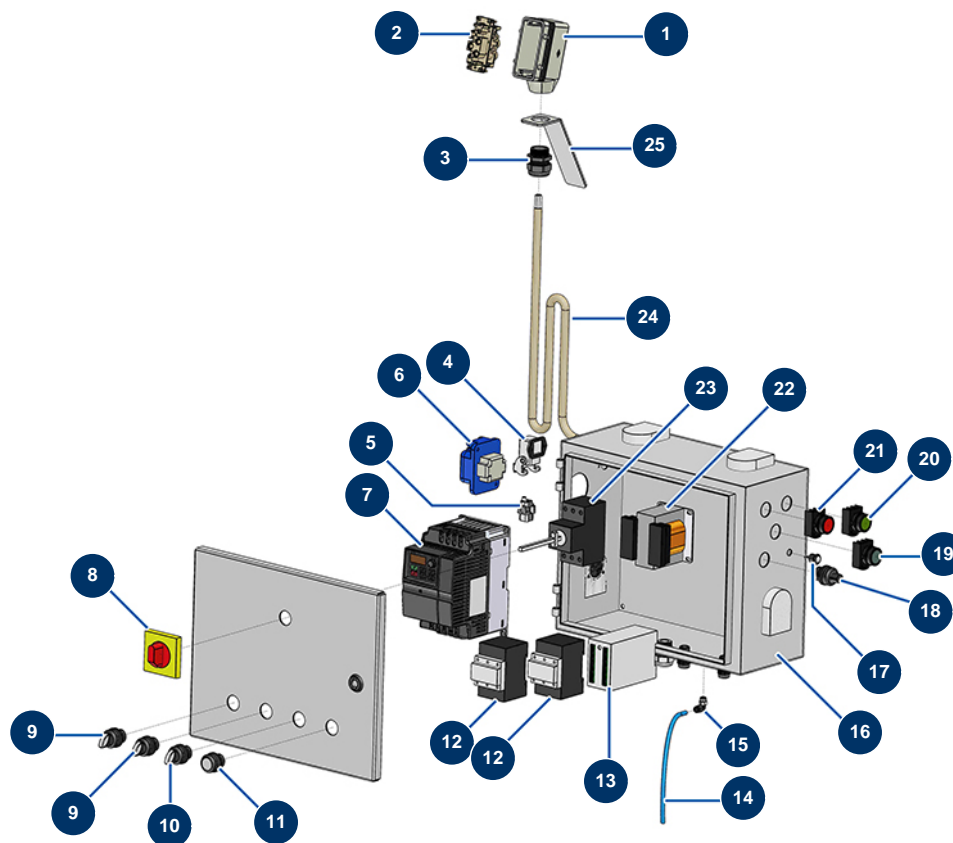

Détails des pièces

Pos.	Référence	Désignation
1	MI3C02800100	Mobile Base
2	MI3C02700600	Female motor safety socket
3	MI3C04200200	PG16 cable gland
4	MI3C02800500	Angled base
5	MI3C02700200	Female insert 4 P + T
6	MI3C02601001	MIXPRO 28 straight socket F 2P + T 16A
7	MI3C05100107	MOSQUITO/SPRINTER, PLUS MONO & MIXPRO 28 inverter - 2,2KW
8	MI3C01300207	ABB main start stop button
9	MI3C01403110	2 position button for SPRINTER/MIXPRO 28 box
10	MI3C01403100	3 position button for SPRINTER/MIXPRO 28 box
11	MI3C04000120	Pulse transparent indicator button for SPRINTER/MIXPRO 28 box
12	MI3C00700117	4 KW 24V AC coil contactor

Pos.	Référence	Désignation
13	MI3C03202500	MOSQUITO, SPRINTER black box
14	MI3G50500100	Calibrated polyurethane tube ø 4 x 6 black by the metre
15	MI3G50400202	Legris angled connection F1/8" ø 6
16	MI3C00107100	Single metal case for machine MIXPRO 28, SPRINTER
17	MI8055000100	Neon bulb
18	MI3C00300400	Complete potentiometer for SPRINTER/MIXPRO 28 box
19	MI3C04000118	Complete blue impulse button
20	MI3C04000105	Green button ø 22 mm
21	MI3C04000104	Red button ø 22 mm
22	MI3C00500101	220 V transformer
23	MI3C01030108	Main switch
24	MI3C03900008	7 x 2,5 motor power cable by the metre
25	MI4906512000	Safety bracket for motor electrical socket

MIXPRO 28 - 2,2 kW complete plaster continuous mixing machine - Electrical box (up to 12/2020)

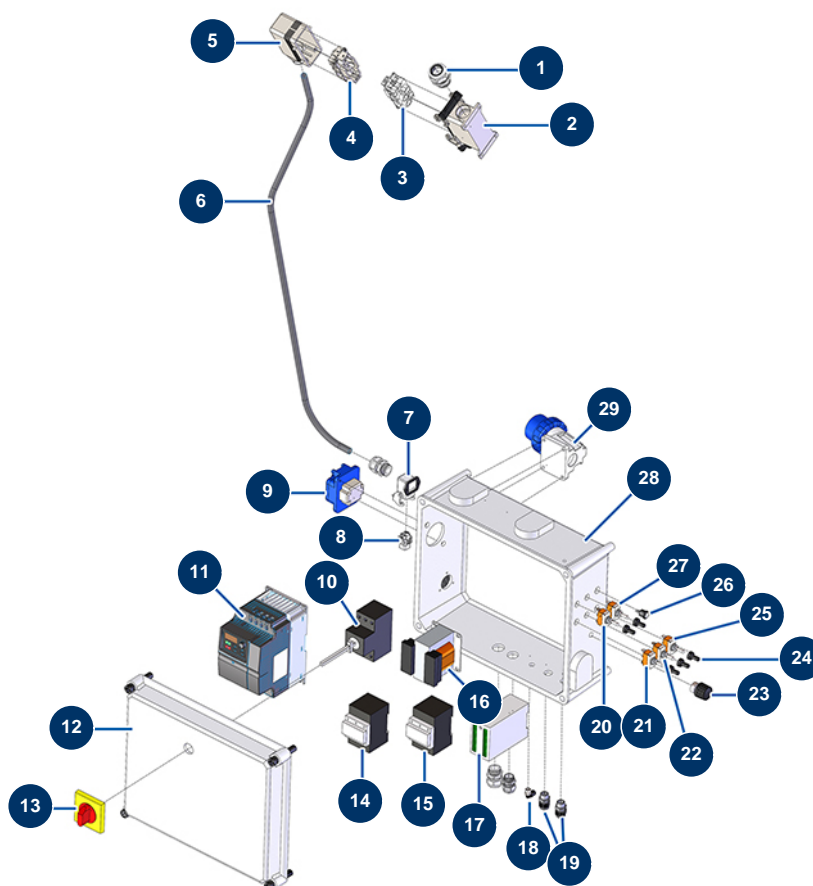

Détails des pièces

Pos.	Référence	Désignation
1	MI3C04200208	PG21 cable gland
2	MI3C02800400	Fixed Base
3	MI3C03100400	Male motor safety socket
4	MI3C02700600	Female motor safety socket
5	MI3C02800100	Mobile Base
6	MI3C03900008	7 x 2,5 motor power cable by the metre
7	12543	Insulating bend socket base 3p + G - 1 lever
8	11914	Female insert 4p + G
9	MI3C02601001	MIXPRO 28 straight socket F 2P + T 16A
10	MI3C01030108	Main switch
11	MI3C05100107	MOSQUITO/SPRINTER, PLUS MONO & MIXPRO 28 inverter - 2,2KW
12	MI3C00110163	MIXPRO 28 plastic box door

Pos.	Référence	Désignation
13	MI3C01300207	ABB main start stop button
14	MI3C00700117	4 KW 24V AC coil contactor
15	MI3C00700110	3RT10251A 7,5KW 24V AC coil contactor
16	MI3C00500101	220 V transformer
17	MI3C03202500	MOSQUITO, SPRINTER black box
18	30124	Corrugated Legris coupling M1/8" Ø 6
19	MI3C04200201	PG 09 watertight cable gland
20	MI3C01800402	T315N-A ON-ON switch
21	MI3C01800500	1-0 T115 A-A switch
22	MI3C01800100	1-0-1 T115 E-A switch
23	MI3C00300101	MIXPRO28/SPRINTER/MOSQUITO machine potentiometer
24	MI3C02100100	Cover for switch
25	MI3C01800200	Main Switch
26	MI8055000100	Neon bulb
27	MI3C01801000	1-0 T115 F-A switch
28	MI3C00110464	Plastic case without door for MIXPRO 28
29	MI3C03000103	Elbow socket for male base 220V

MIXPRO 28 - 2,2 kW complete plaster continuous mixing machine - Spraying lance

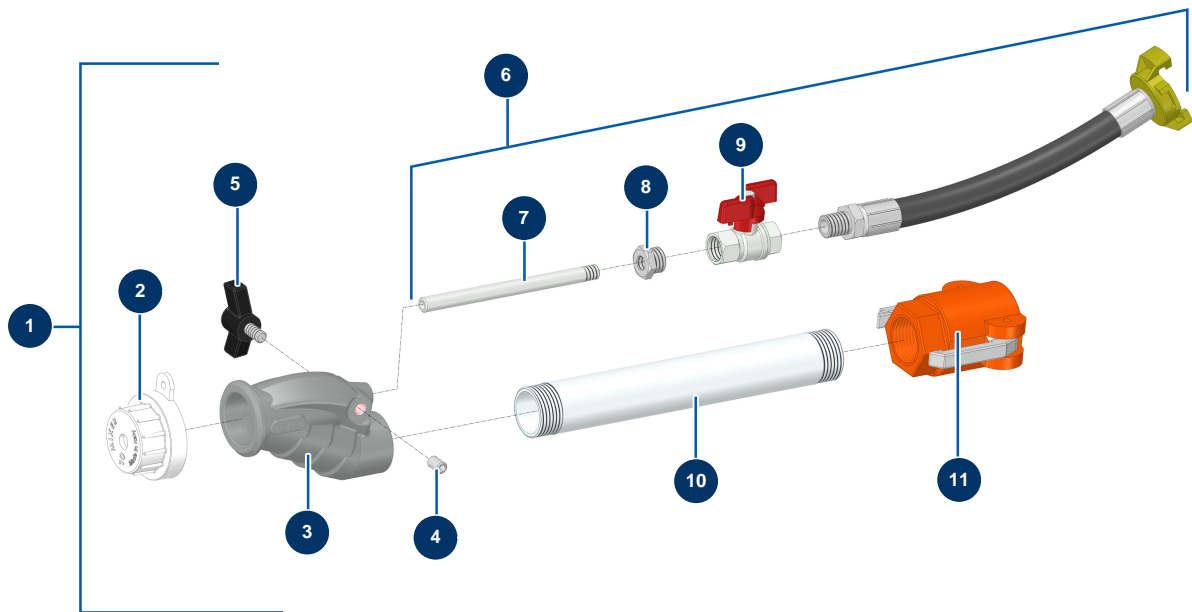

Détails des pièces

Pos.	Référence	Désignation
1	MI8010003005	MIXER standard Aluminium Lance
2	MI3F00200101	White spraying nozzle Ø 10 80SH
3	MI4916001000	Mixer straight lance head
4	14151	8 x 12 stainless steel socket head screw with flat tip
5	MI3T01505001	Mixer black Eye bolt diam 8
6	MI8010100001	Mixer aluminium standard spray lance air regulation kit
7	MI4907402000	Outer threaded air injector
8	MI3G50300102	8
9	MI3G01300103	9
10	MI4907441001	230 mm extension outer threaded tube
11	MI3A00300241	1" camlock polypro coupling, inner threaded 1"

MIXPRO 28 - 2,2 kW complete plaster continuous mixing machine - Hoses

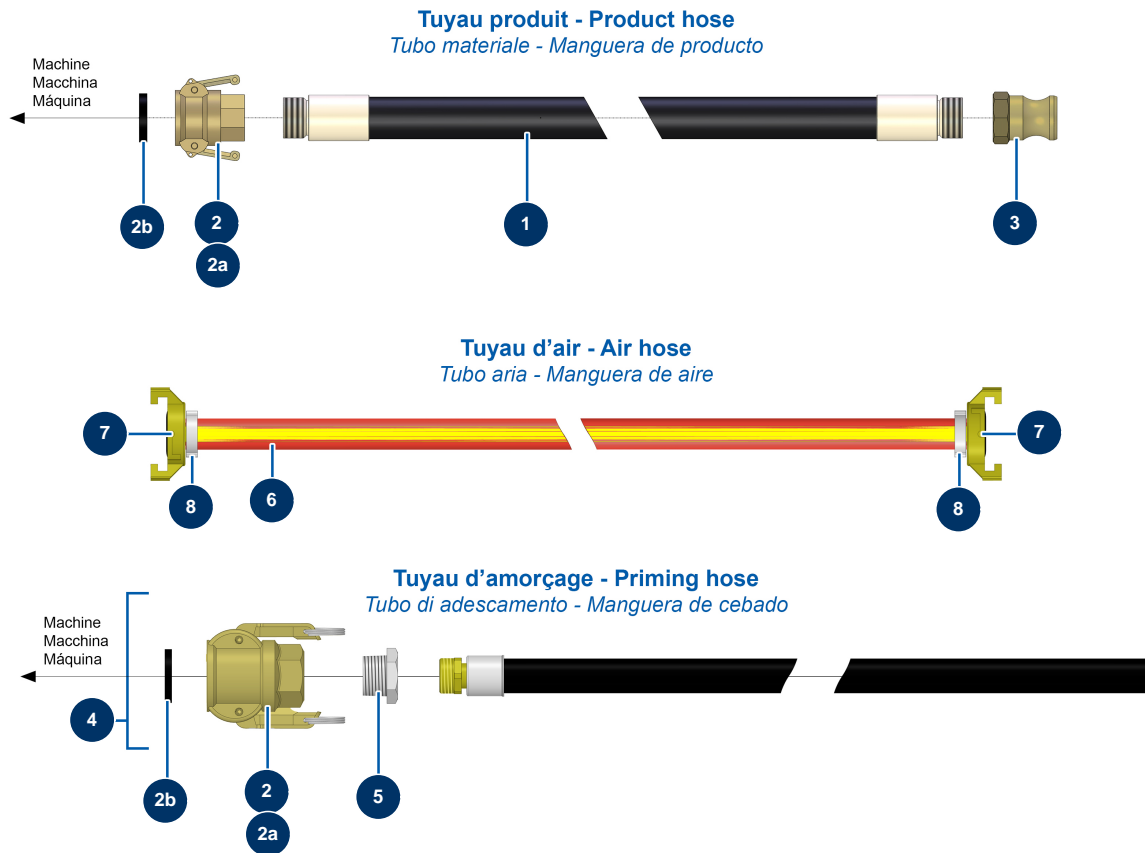

Détails des pièces

Pos.	Référence	Désignation
1	50014	25 x 15 m product hose outer threaded 1" without couplers
2	11950	1" camlock steel coupling, inner threaded 1"
2a	12978	Product and lance hose steel cam coupler - C.P 60
2b	70014	1" cam coupler gasket
3	11952	1"ø 27 steel adapter, inner threaded 1"
4	12012	Pouring product hose Ø 19 x 2 m - 1" coupling MIXPRO 28, 30, 50
5	90789	1" MaleC x 3/4 FemaleD low-pressure reduction
6	MI3F00700201	Yellow and red PVC hose ø 13 x 19 by the metre
7	MI3G00200301	7
8	MI3A00100102	Corrugated Geka coupling of 13