

JETPRO 100-7 complete atomizer - Chassis

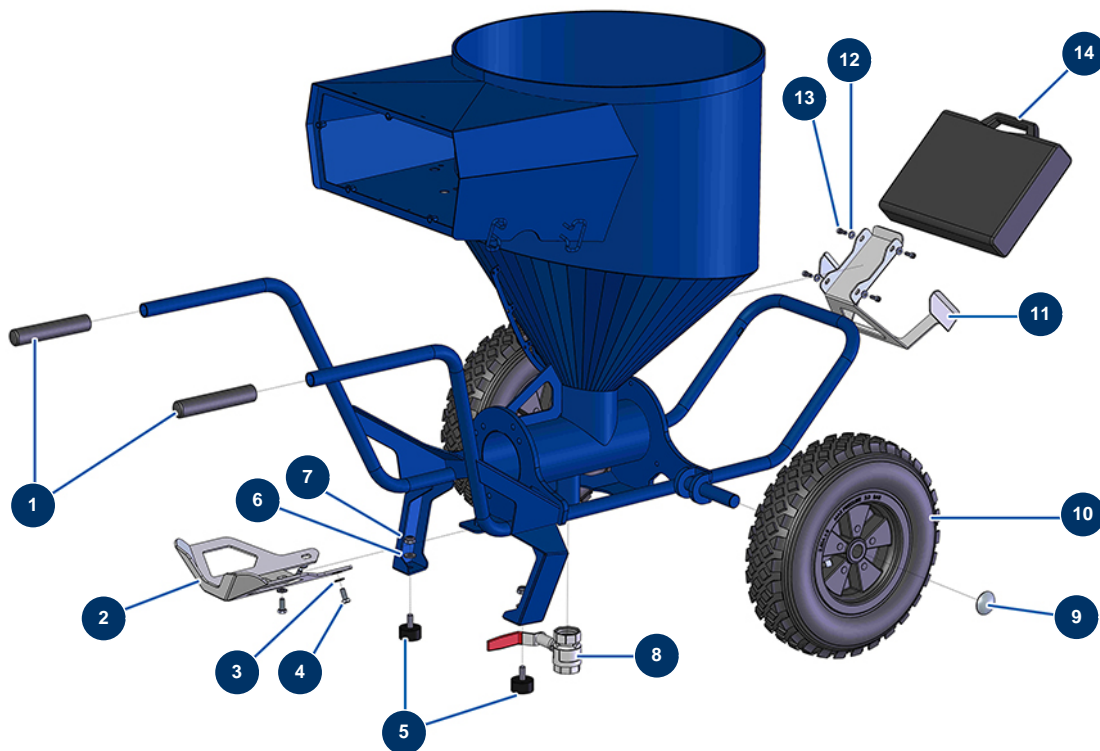

Détails des pièces

Pos.	Référence	Désignation
1	90255	Arm handle for EUROPRO 24P, E50 and E100
2	C22683	2
3	80260	ø 8 inox medium washer
4	30273	THEF 8 x 20 screw
5	30145	Ø 40 x 20 M10 stop
6	80261	ø 10 inox medium washer
7	13981	M 10 nylstop inox nut
8	14584	EUROPRO DROPPRO 30P drain valve
9	90282	Ø25 chromed clip
10	80003	Ø400 complete wheel with shaft of 25 for 100TH, MPE 300
11	C22709	11
12	80259	Ø 6 medium washer
13	90157	M6 x 16 cylindrical head screw - CP 60

Pos.	Référence	Désignation
14	90603	Empty case for lance