

Intonacatrice airless JETPRO 100-7 completa - Telaio

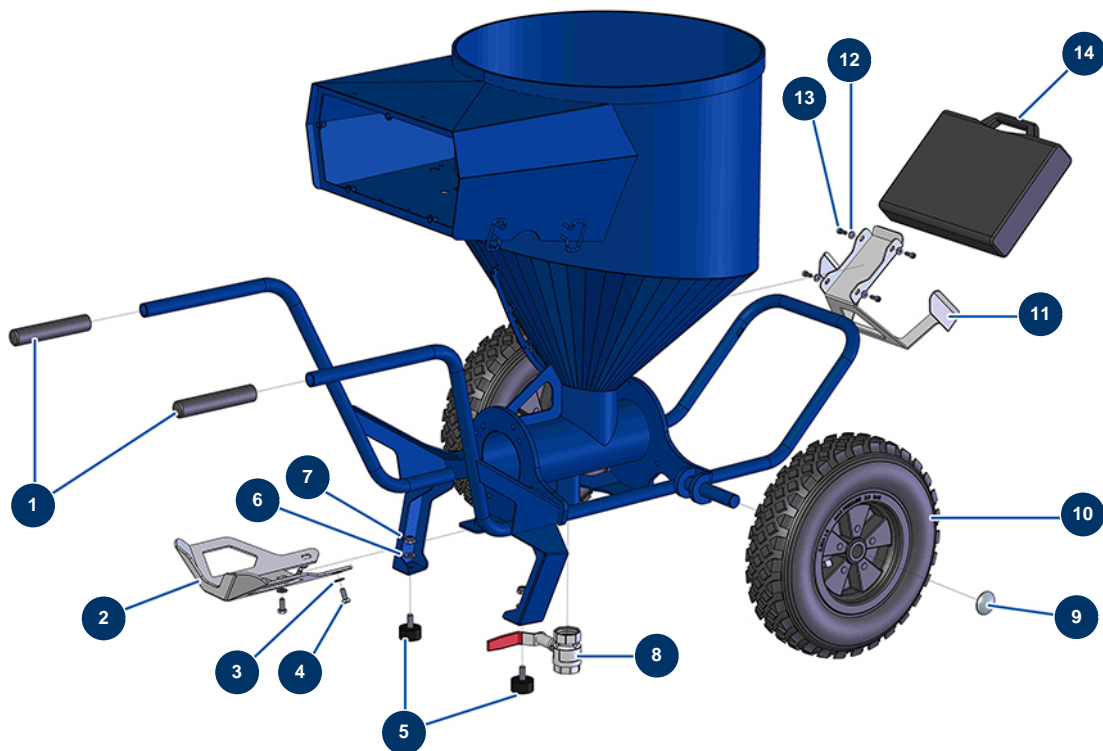

Détails des pièces

Pos.	Référence	Désignation
1	90255	Impugnatura braccio EUROPRO 24P e compress. 50 e 100
2	C22683	2
3	80260	Rondella media ø 8 inox
4	30273	Vite THEF 8 x 20
5	30145	Battuta ø 40 x 20 M10
6	80261	Rondella media ø 10 inox
7	13981	Dado M 10 nylstop inox
8	14584	Valvola di scarico EUROPRO DROPPRO 30P
9	90282	Clip cromate ø 25
10	80003	Ruota completa 400 albero da 25 per 100TH, MPE 300
11	C22709	11
12	80259	Rondella media ø 6
13	90157	Vite testa cilindrica M6 x 16 - CP 60

Pos.	Référence	Désignation
14	90603	Valigetta vuota per lancia