

## TURBISOL 56/2 blowing machine - Carding shaft with simple blades

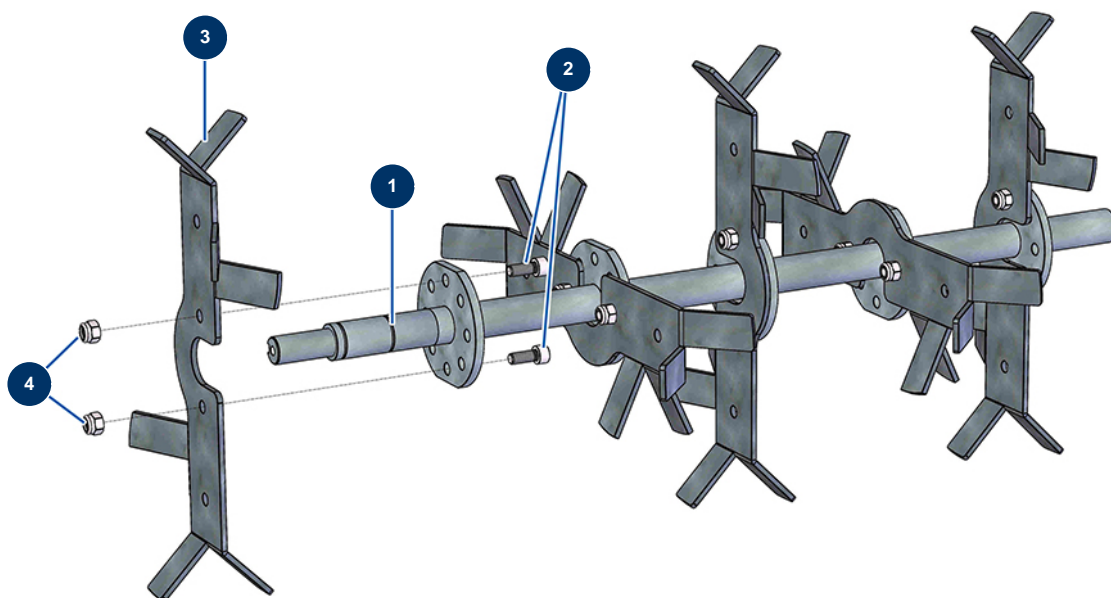

### Détails des pièces

Pos.	Référence	Désignation
1	C22864	Single 5-blades mixing shaft for TURBISOL 56 Evo2, 112 & 164
2	90157	M6 x 16 cylindrical head screw - CP 60
3	C22865	TURBISOL 56 Evo2 simple carding paddle
4	14217	M 6 nylstop inox nut